

# DIN 41612 EUROCARD CONNECTOR



## 2232 SERIES. Female right angle. Type Half Q Connectors

Circuit Size	Configuration	Part Number			
		PCB Solder 4 mm	Wrap post tail length 13 mm	Wrap post tail length 17 mm	-
16	a	2232 - T061	-	-	-
16	a + b	2232 - T161	-	-	-
32	a + b	2232 - T321	-	-	-

a	0.3 x 0.63
4	PCB Solder

a	□ 0.6 x 0.69
13	Wrap post

a	□ 0.6 x 0.69
17	Wrap post

T = Plating and class connector

- T = 3. 0.20 μ" over 1.27 μ" Ni. 200 cycles class 2B
- T = 4. 0.38 μ" over 1.27 μ" Ni. 400 cycles class 2
- T = 5. 0.76 μ" over 1.27 μ" Ni. 500 cycles class 1

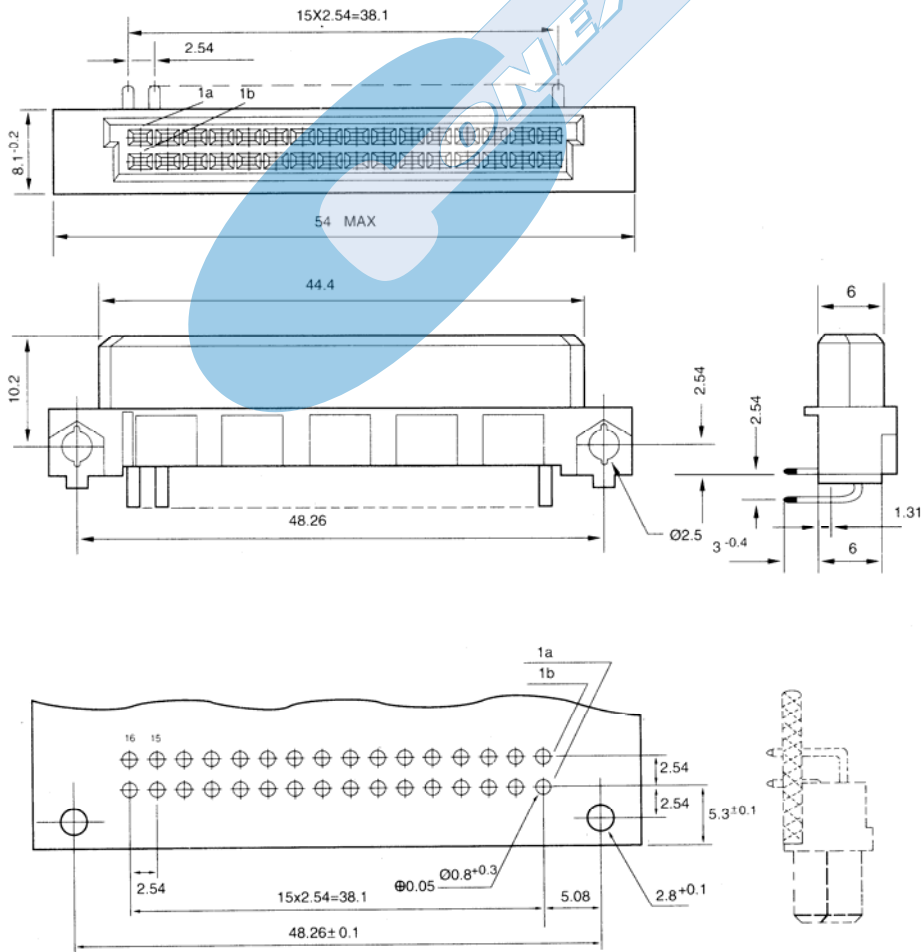
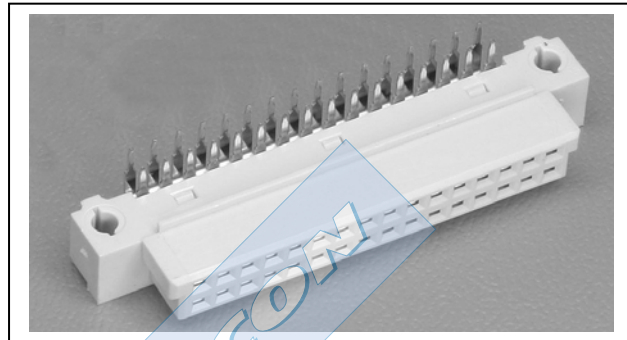

RECOMMENDED HOLE PATTERN